

# TECHNIA

ADDNODE GROUP



## Lite3D

Establish 3D as an affordable common collaboration language beyond engineering throughout the extended enterprise.

EXPERIENCE PACKAGED



Professional JT portfolio driven by customer input with solid release cycle

ISO based own JT toolkit with full control and best performance

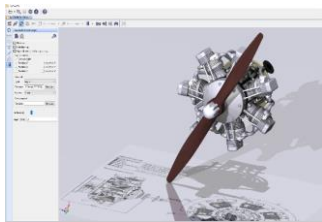

**LiteBox3D**

Desktop and Web Viewing

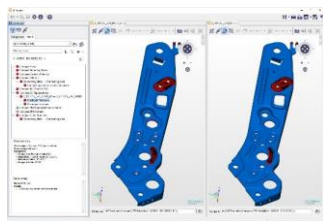

**xCompare**

Validation

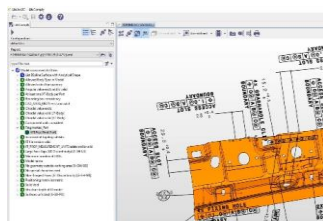

**LiteComply**

Data Quality

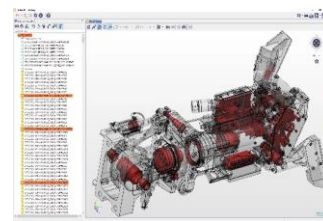

**LiteDrop**

Data Simplification & IP Protection

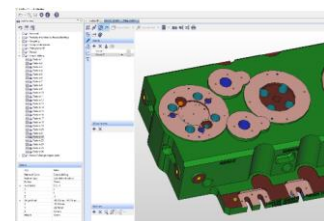

**LiteMachine**

Design to Manufacture

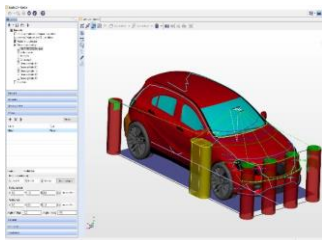

**LiteCar**

Vehicle Homologation

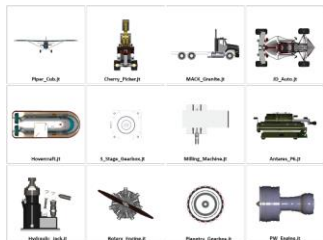

**LiteImage**

Image Capturing (Batch)

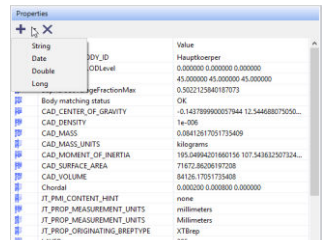

**LiteProperties**

Properties editing (batch)

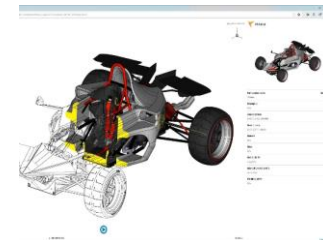

**3DHTML**

3DHTML creator (batch)



**Custom Apps**

LiteSilhouette, LiteCCC, ...

## Data Clearing – IP Protection and Simplification

Extract process specific content & IP from a Master JT file

High performance JTs with just what's needed and you want to share

Removal of invisible parts

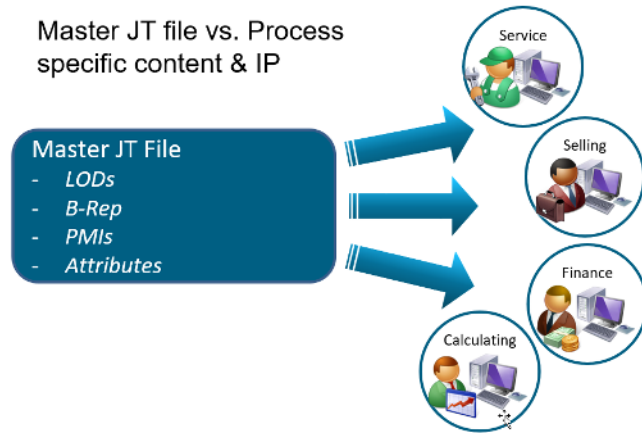

Bidding & Inquiry  
- LODs (low accuracy) only

High end Visualization  
- B-Rep only

Manufacturing / Shop floor  
- LOD & PMIs

After Sales  
- LOD (finest) & Properties

Others.... i.e. viewing by web  
- As small as possible

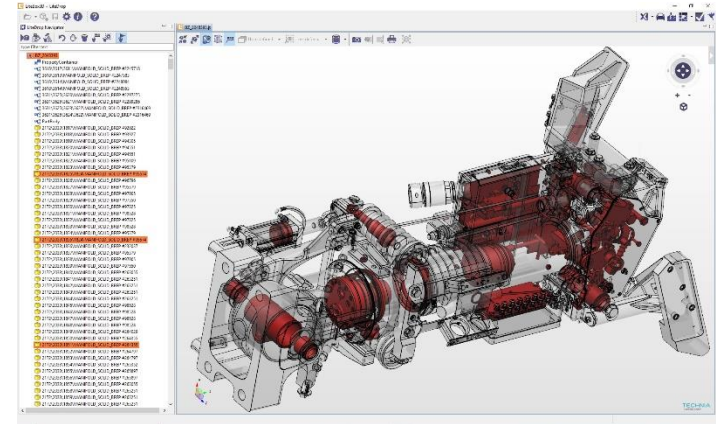

# LiteDrop



- Remove specific content / nodes of the JT file
  - By type, i.e. XT / JT B-Rep, PMIs, LODs + number
  - By name, i.e. specific properties only
  - Remove invisible Parts / inner bodies
- Reduce file size for processes which do not require all details
- Interactive integration in LiteBox3D & Batch for automated processes

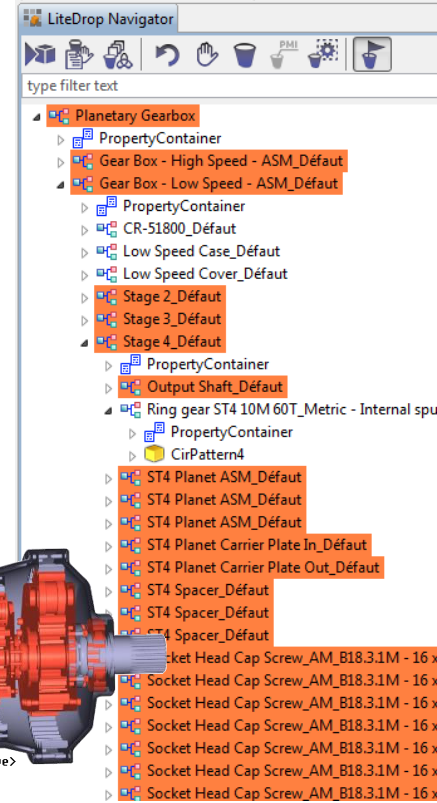

```
Listar - [d:\Program Files\TechniaTranscat\Lite3D_2016.1\LiteDrop\con
Datei Bearbeiten Optionen Codierung Hilfe
<?xml version="1.0"?>
<iprotection>
<profile id="0" name="DAF Simplification" descrip
<remove match="part[name ~ '13131']" active="true"></remove>
<remove match="assembly[name ~ 'MEPT']" active="true"></remove>
<remove match="part[name ~ '12430']" active="true"></remove>
<remove match="part[name ~ 'MODEL_MF']" active="true"></remove>
<remove match="part[name ~ 'RING']" active="true"></remove>
<remove match="part[name ~ 'RING1']" active="true"></remove>
<remove match="part[name ~ 'BOU1']" active="true"></remove>
<remove match="part[name ~ 'bus_klen']" active="true"></remove>
<remove match="part[name ~ 'schroef']" active="true"></remove>
<remove match="part[name ~ '1231062']" active="true"></remove>
<remove match="part[name ~ '1231052']" active="true"></remove>
<remove match="part[name ~ '1398677']" active="true"></remove>
<remove match="part[name ~ '1277786']" active="true"></remove>
<remove match="part[name ~ '1231064']" active="true"></remove>
```

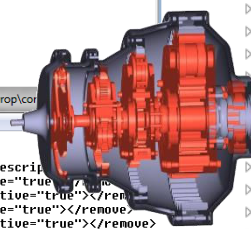

# LiteDrop

## Video

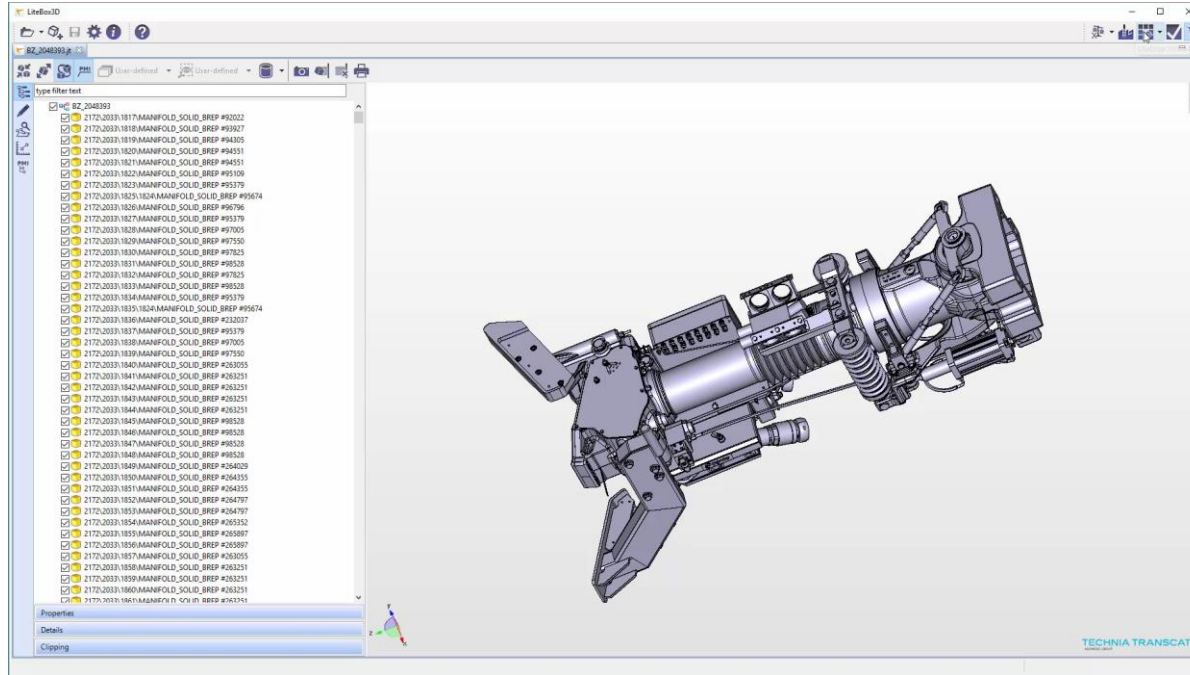

[https://www.youtube.com/watch?v=D3VWZcq\\_iRM](https://www.youtube.com/watch?v=D3VWZcq_iRM)



# TECHNIA

ADDNODE GROUP



+49 721 970 43 74



[arnd.feye@technia.com](mailto:arnd.feye@technia.com)

EXPERIENCE MATTERS

